



Matis

NAMEŠTAJ • www.matis.rs

Senjak bb*32250 Ivanjica*Srbija

Tel:032 651 159* Fax:032 651 060

office@matis.rs*veleprodaja@matis.rs*www.matis.rs



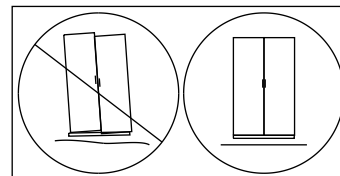
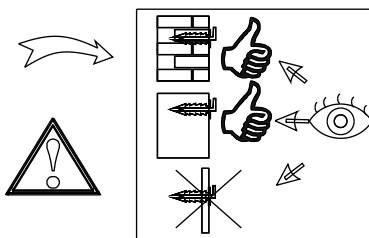
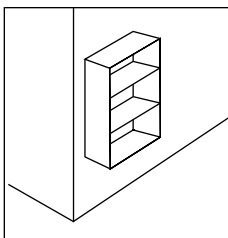
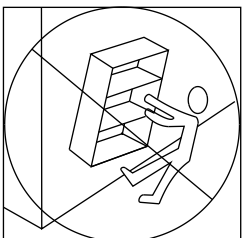
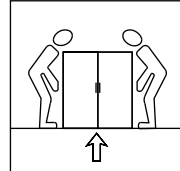
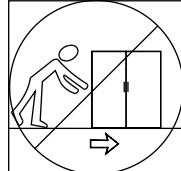
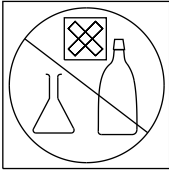
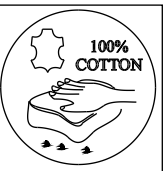
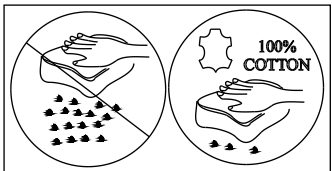
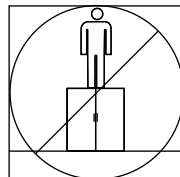
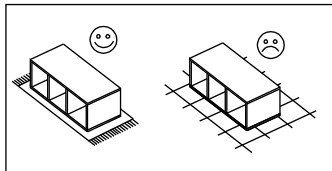
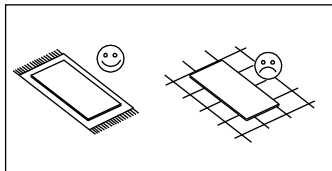
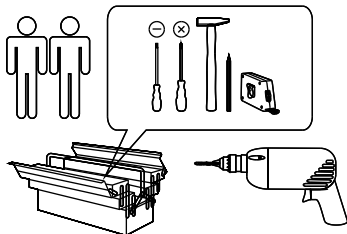
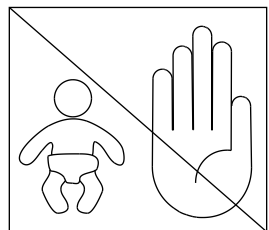
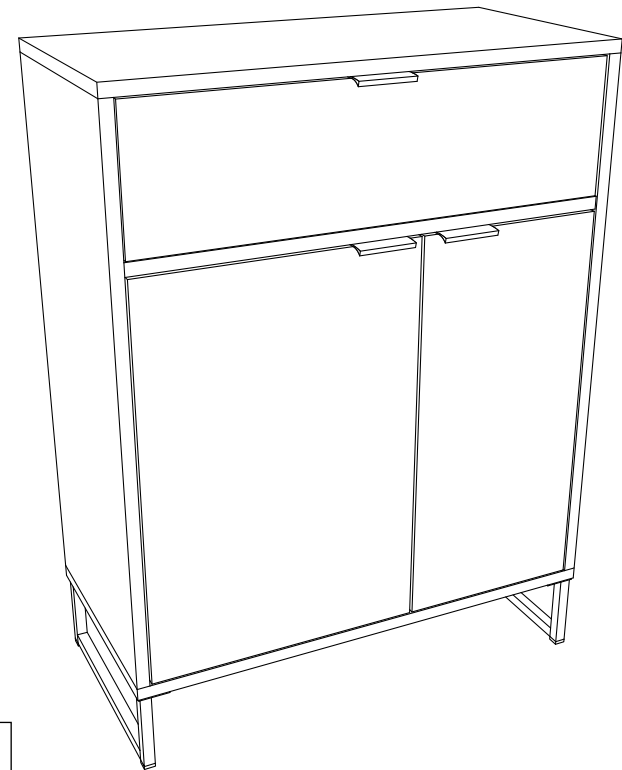

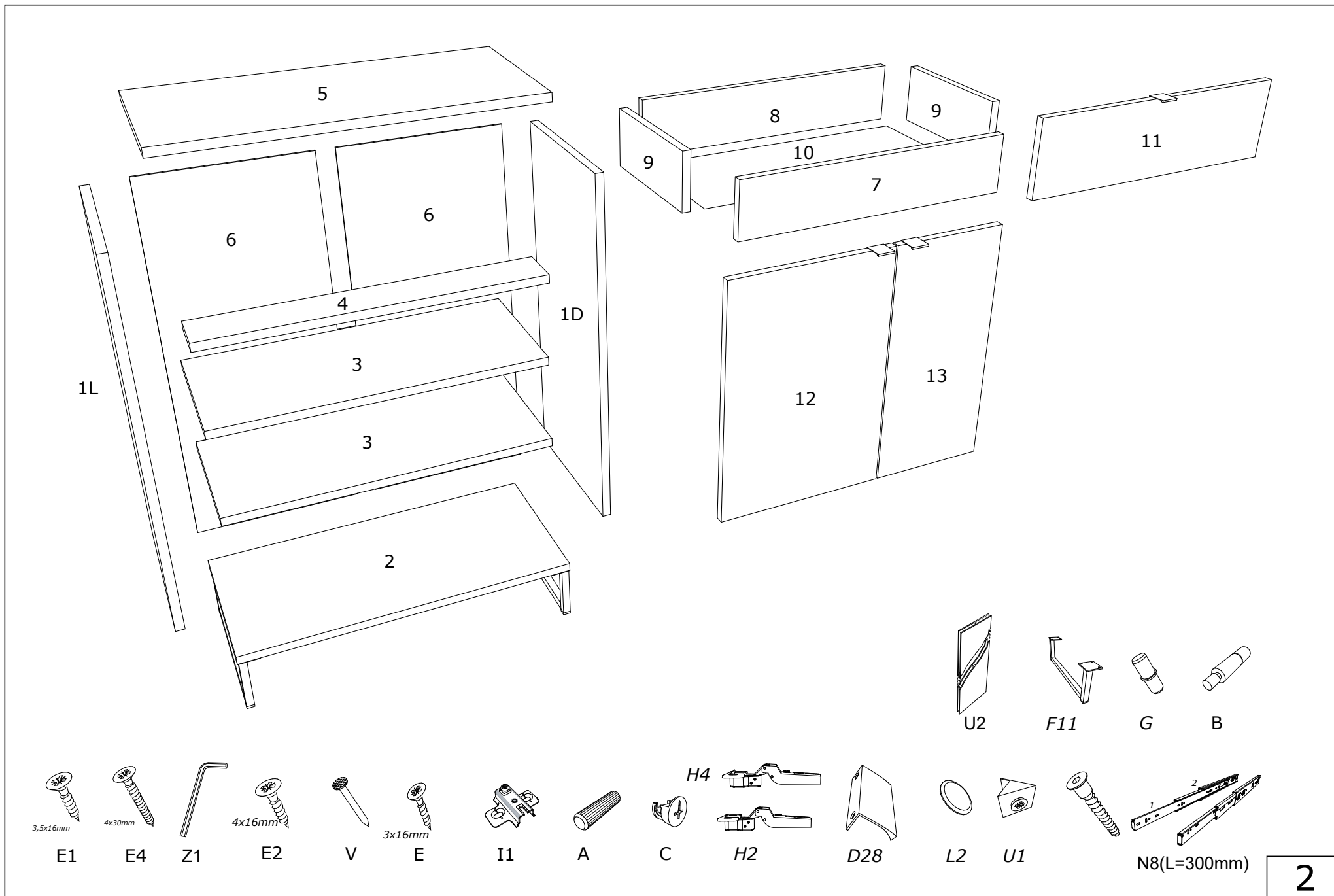

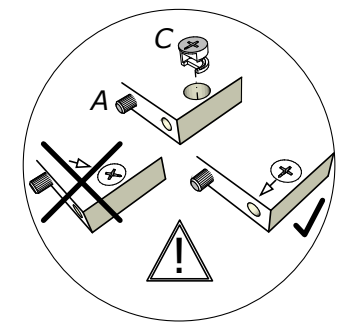
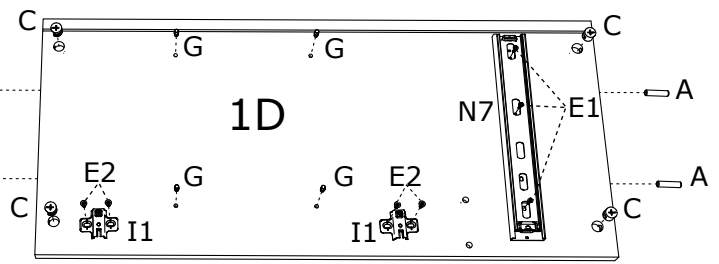
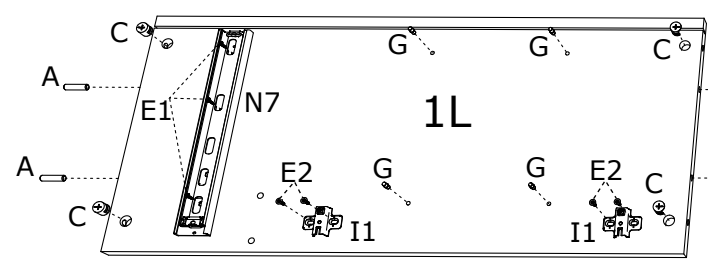
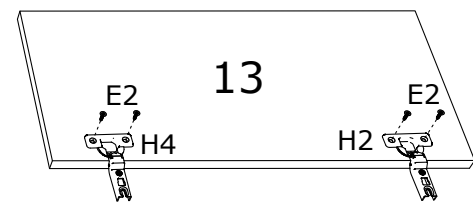
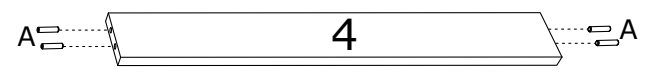
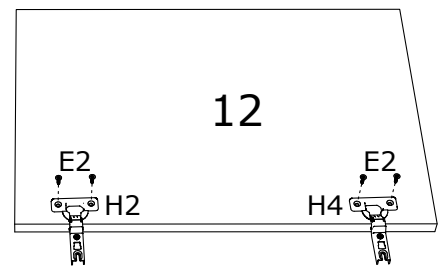
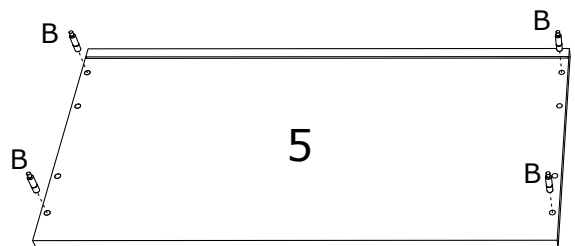
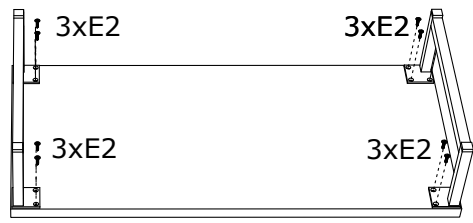
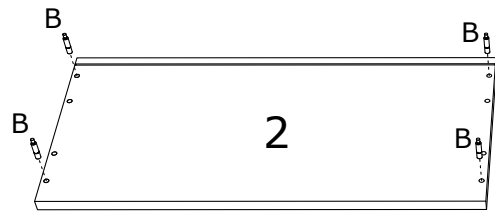
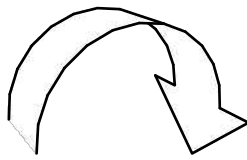

PREDSOBLJE DENVER CIPELAR





PREDSOBLJE DENVER CIPELAR

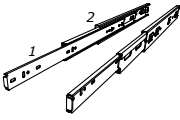

- 
 3,5x16mm
 E1
- 
 4x16mm
 E2
- 
 I1
- 
 A
- 
 C
- 
 H2
- 
 B
- 
 G
- 
 N8(L=300mm)

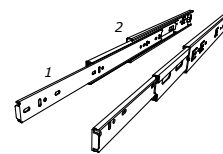
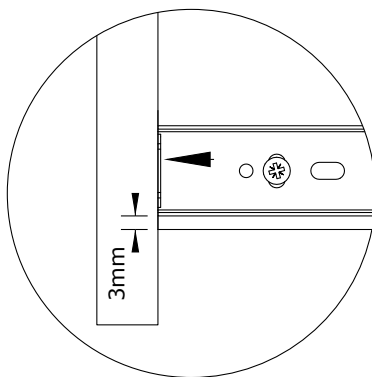
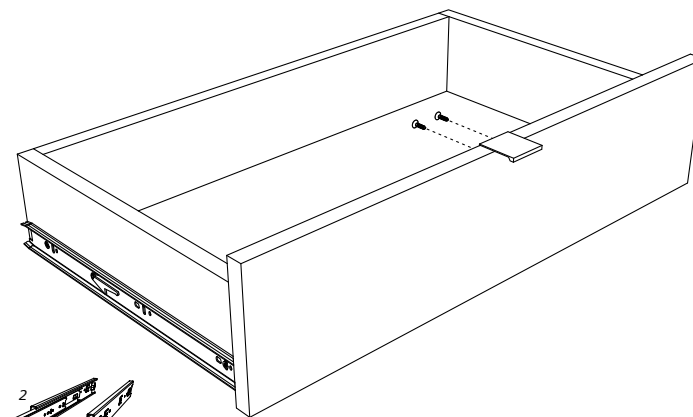
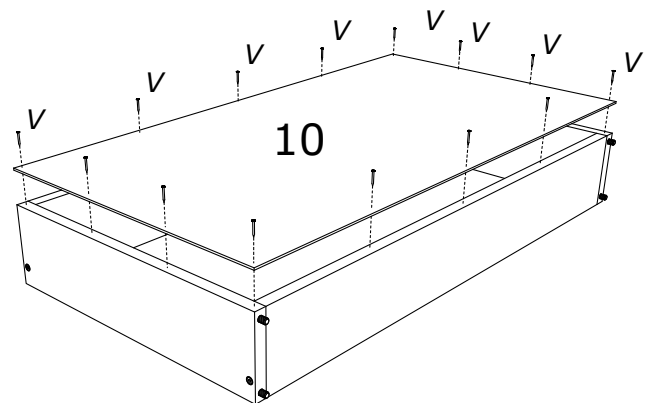
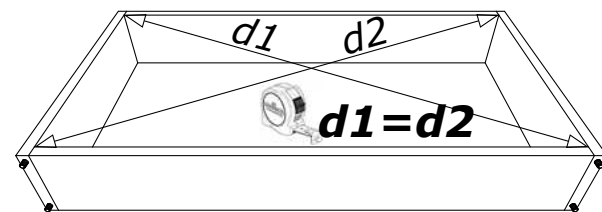
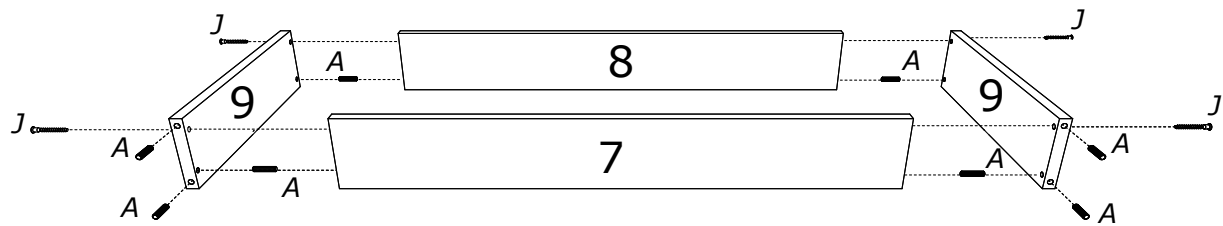

N8(L=300mm)

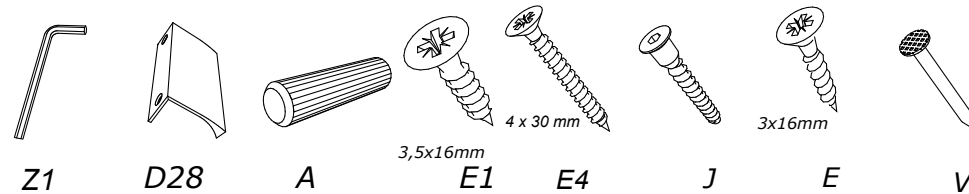
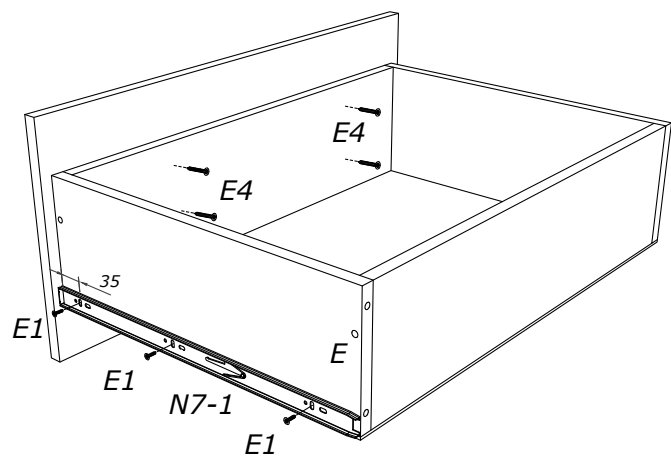

Z1

D28

A

3,5x16mm

E1

E4

J

E

V

