



N A M E Š T A J • [www.matis.rs](http://www.matis.rs)  
Senjak bb\*32250 Ivanjica\*Srbija

Tel:032 651 159\* Fax:032 651 060

[office@matris.rs](mailto:office@matris.rs)\*[veleprodaja@matris.rs](mailto:veleprodaja@matris.rs)\*[www.matis.rs](http://www.matis.rs)

## SPAVAĆA SOBA KALIOPA FIOKA KREVETA

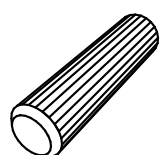
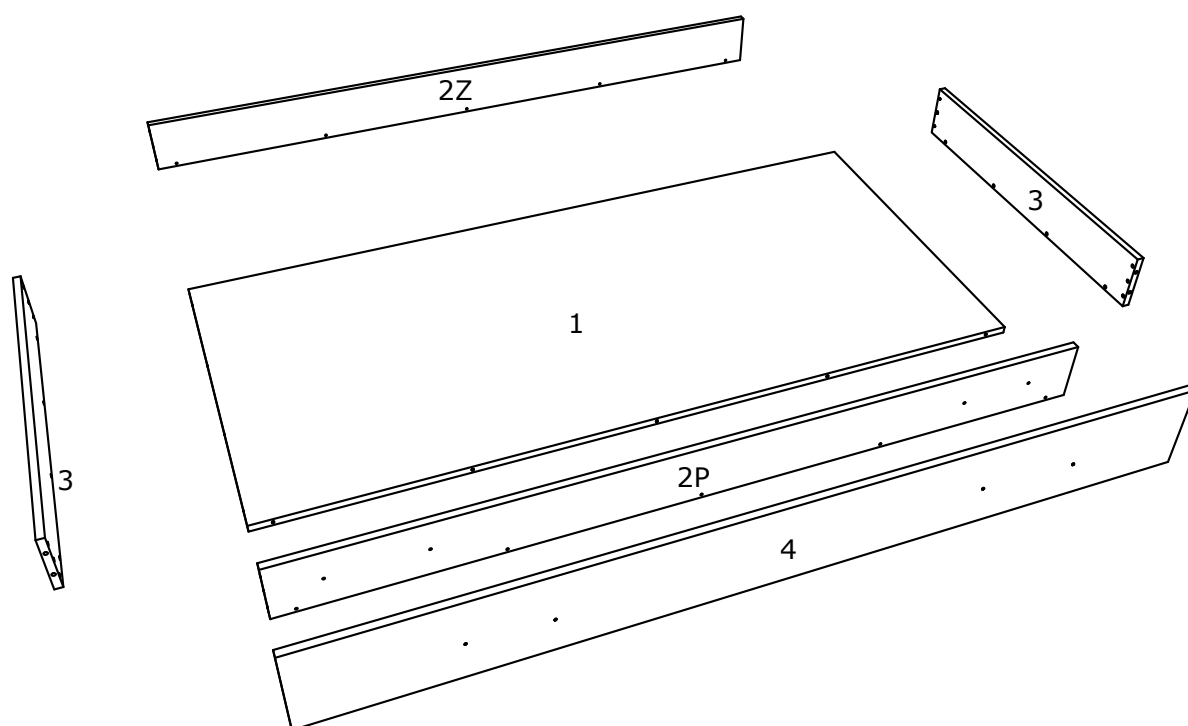
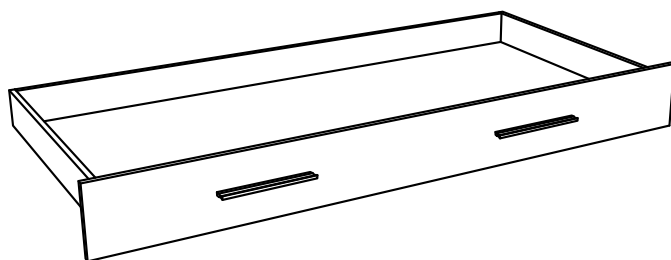

A



4 x 16 mm

E2

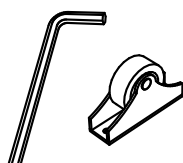

Z1

T1



R1



4 x 30 mm

E4

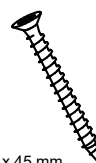

4 x 45 mm

E12

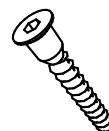

J

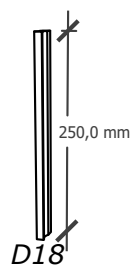

250,0 mm

D18

